

LCD Display

CL-55KMF10



CIMA 
Digital Evolution
<http://www.cimadigitec.com>

Owner's Instructions

Before operating the unit, please read this manual thoroughly,
and retain it for future reference.

This multi-LCD Display system supports high resolution and multi-screen format up to 127. So these monitors can be used individually or all together.

There are various designs such as wall-mounting or stand-alone type for the best installation.



You can connect the player directly to the LCD Display or network for a remote control.

- Provides real-time information like weather and traffic reports, stock market information, etc.
- Provides display solution used as in-store mediums to present product advertisement, full motion video, photo-realistic graphics, text and animation.
- Designed for simple installation and maintenance
- Cost efficient for maintenance and handling.
- Needs only a small space because of the ultra slim LCD Display.

Contents

CAUTION	2
Important Safety Instruction	3
Precaution	4
Before considering as a failure	4
About LCD display panel	4
Unpacking and Setup	5
Scope of Supply	5
Viewing the control	5
Rear View.....	5
Remote Control	6
Connection and start Operation	7
Connecting the Cables	7
Connecting to a Computer	8
Connecting to External Devices with Component Input	8
Connecting Several Devices	8
Inserting the Batteries	9
Settings	10
Switching on	10
Switching Off	10
Setting up for Operation	10
DIP Switch Setting(No.0~69)	11
DIP Switch Setting(No.70~128).....	12
Setting ID Example for LCD display panel	13
Connecting RS-232C Cable	13
Connecting S-Video Cable	14
Connecting VGA Cable	14
Connecting the Power Cord	15
AC Power Connection	15
Set Screen Language	16
Set Geometry	16
Set MISC.	16
Select Source (Main Input).....	17
Troubleshooting	18
Technical Specifications	19
Memo	20

CAUTION

	CAUTION RISK OF ELECTRIC SHOCK. DO NOT OPEN	
CAUTION : TO PREVENT ELECTRICAL SHOCK, DO NOT REMOVE REAR COVER. NO USER SERVICEABLE PARTS INSIDE. REFER SERVICING TO QUALIFIED SERVICE PERSONNEL.		

	The Lightning flash and arrow head within the triangle is a warning sign alerting you of “dangerous voltage” inside the product.
---	---

	This symbol indicates additional safety instructions in the text.
---	--

	This symbol indicates instructions to facilitate the operation.
---	--

FCC NOTICE
<p>This device has been tested and found to comply with the limits for a Class B device, pursuant to Part 15 of the FCC Rules. These limits are designed to provide reasonable protection against harmful interference in home environment as well as in a commercial, industrial or business environment. This equipment can generate, use and radiate radio frequency energy and, if not installed and used in accordance with the instruction, may cause harmful interference to radio communications. However, there is no guarantee that interference will not occur in a particular installation. If this equipment does cause harmful interference to radio or Monitor reception, which can be determined by turning the equipment off and on, the user is encouraged to try to correct the interference by one or more of the following measures:</p> <ul style="list-style-type: none">- Reorient or relocate the receiving antenna.- Increase the separation between the equipment and receiver.- Connect the equipment into an outlet on a circuit different from that to which the receiver is connected.- Consult the dealer or an experienced radio/LCD display panel technician for help. <p>Changes or modification not expressly approved by the party responsible for compliance could void the user’s authority to operate the equipment.</p> <p>Connecting of peripherals requires the use of grounded shielded signal cables.</p>

Important Safety Instruction

- Read these instructions.
- Keep these instructions.
- Heed all warnings.
- Follow all instructions.
- Do not use this apparatus near water.
- Clean only with a dry cloth.
- Do not block any of the ventilation openings. Install in accordance with the manufacturer's instructions.
- Do not install near any heat sources such as radiators, heat registers, stoves, or other apparatus (including amplifiers) that produce heat.
- Do not defeat the safety purpose of the polarized or grounding type plug. A polarized plug has two blades with one wider than the other. A grounding type plug has two blades and a third grounding prong. The wide blade or the third prong is provided for your safety. When the provided plug does not fit into your outlet, consult an electrician for the replacement of the obsolete outlet.
- Protect the power cord from being walked on or pinched particularly at plugs, convenience receptacles and the point where they exit from the apparatus.
- Only use the attachments/accessories specified by Runco Systems.
- Use only with a cart, stand, tripod, bracket or table specified by the manufacturer or sold with the apparatus. When a cart is used, use caution when moving the cart/apparatus to avoid injury from tip-over.
- Unplug this apparatus during lightning storms or when unused for long periods of time.
- Refer all servicing to qualified service personnel. Servicing is required when the apparatus has been damaged in any way, such as power supply cord or plug is damaged, liquid has been spilled or objects have fallen into the apparatus, the apparatus has been exposed to rain or moisture, does not operate normally, or has been dropped.



Precaution

■ Before considering as a failure

Before calling for any repair, check the following and then refer to a near A/S center.

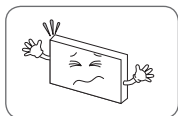

▶ **“Tick” sound from the main body.**

If there is no problem with the screen or sound, the “tick” sound is likely to result from the cabinet lightly shrinking with change of room temperature. The sound does not affect product’s performance.

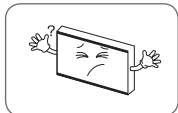

▶ **No image at upper and bottom part of screen.**

As for a screen which is over 16:9 in width (such as cinema-sized one) no image may be displayed at upper and bottom part of the screen.

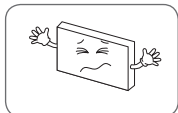

▶ **Speckles or white lines on the screen**

Check whether the problem is caused by vehicle, streetcar, high voltage cable or neon sign, which interference wave or electromagnetic induction. Avoid any interfering object.

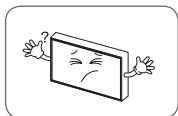

▶ **Screen size can be changed.**

The screen size may be fitted to the first dark scene depending on contents.

■ About LCD display panel

The followings are phenomena caused by characteristics of the LCD display panel. Since it is not any failure, you may use it at rest.

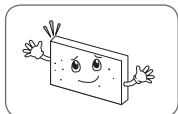

▶ **Black or twinkling spots on the screen**

Although the LCD display panel is manufactured with high-precision technology, there may exist black or twinkling spots on the screen. Since it is not any failure, you may use it at rest.

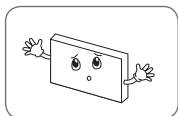

▶ **Noise From the inside**

When you turn on the product, driving sound may be heard from the display panel. Since it is not any failure, you may use it at rest.

Unpacking and Setup

Scope of Supply

Please check, that the delivery is complete.

- | | |
|---------------------------------------|----------------|
| ① Unit | ⑤ Serial Cable |
| ② Remote control & Batteries (AA x 2) | ⑥ VGA Cable |
| ③ Power Cord | ⑦ DVI Cable |
| ④ Operating Instructions | |

Viewing the control

Rear View

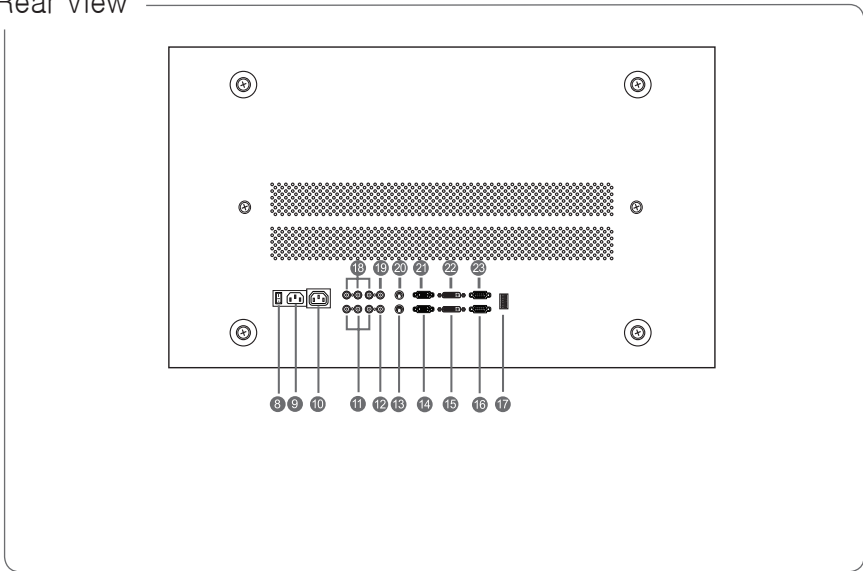

- | | | |
|------------------------------------|-------------------------------------|---------------------|
| ① Input Source selection button | ⑪ Component Video (Y Pb Pr) Input | ⑲ PC (RGB) Output |
| ② Menu Selection button | ⑫ Composite Video Input | ⑳ PC (DVI-D) Output |
| ③ Menu Control button(Left, Right) | ⑬ S-Video Input | ㉑ RS-232C Output |
| ④ Menu Control button(Top, Bottom) | ⑭ PC (RGB) Input | |
| ⑤ Power button(⏻) | ⑮ PC (DVI-D) Input | |
| ⑥ Power Indicator | ⑯ RS-232C Input | |
| ⑦ Remote Control Sensor | ⑰ ID No(DIP Switch) | |
| ⑧ Power Switch(Main) | ⑱ Component Video (Y Pb P r) Output | |
| ⑨ Power Input | ⑳ Composite Video Output | |
| ⑩ Power Output | ㉑ S-Video Output | |

Remote Control

- 1 Power On/Off button
- 2 Numeric buttons
- 3 Favorite Channel Selection
- 4 Volume Up/Down
- 5 Sound Selection (Mono/Stereo/SAP)
- 6 Picture Mode Selection
- 7 Sound Mode Selection
- 8 Control the Cursor in the OSD Menu
- 9 MENU Confirmation
- 10 Display OSD Menu
- 11 Information Display
- 12 DVD Player Function Buttons
(Available in the model that has a built-in DVD Player)
- 13 Temporary Sound Mute
- 14 DVD Player Function
(Available in the model that has a built-in DVD Player)
- 15 External Source Input Selection
- 16 Internet/Media Player Function
- 17 Closed Captions
- 18 Previous Channel
- 19 Picture Size Selection
- 20 SRS WOW Selection
- 21 Exit from the OSD

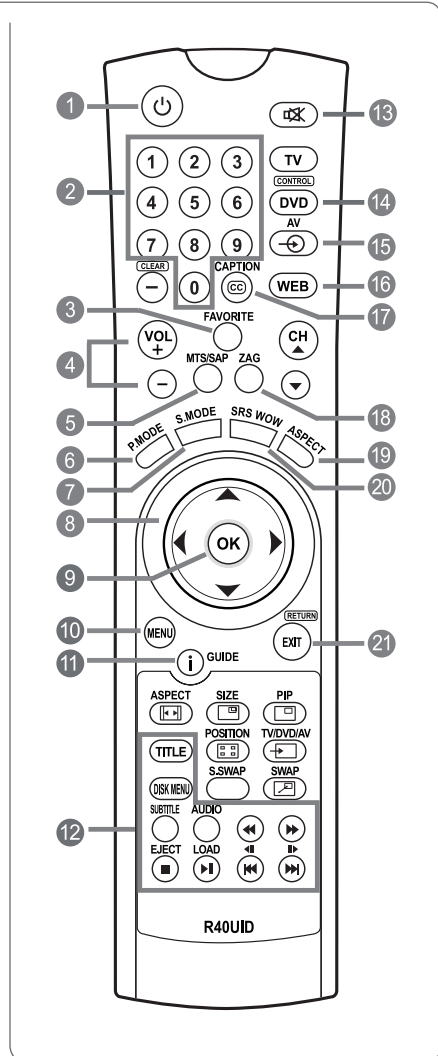

Connection and start Operation

■ Connecting the Cables

You can use the Monitor set to connect camcorder and video games. Use the cinch sockets on the rear side of the unit.

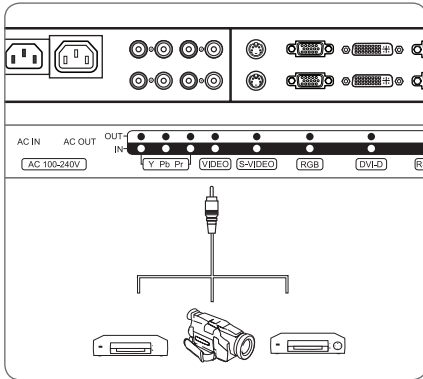

■ Connecting the AV Cable

- 1 Connect the AV cable to the sockets [VIDEO] and the output sockets of the external devices.

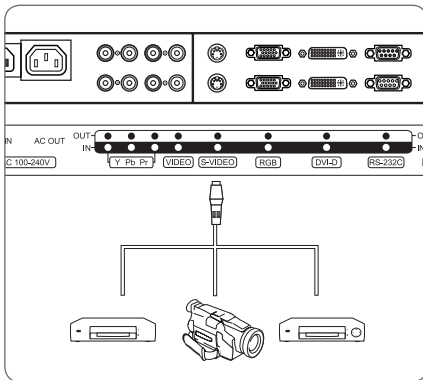

■ Connecting the S-Video Cable

- 1 Connect the S-Video cable to the socket [S-VIDEO] on the rear side of the unit and the output sockets of the external devices.

Connecting to a Computer

Use a 15-pin D-Sub cable or DVI-D cable to connect the LCD display panel set to the computer.

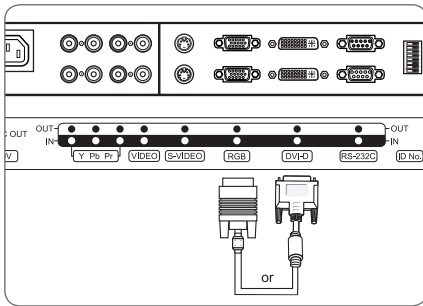

- 1 Plug the cable into the output socket of the graphic board.
- 2 Plug the other end of the cable into the socket [RGB] or [DVI-D].
- 3 Adjust the settings of the Monitor picture corresponding to the settings for Monitor operation. See "Settings" on page 10.



If the LCD display panel does not receive any signal, adjust the output of the computer. For information on how to setup the computer, refer to the corresponding manual of the computer.

Connecting to External Devices with Component Input

You can use the LCD display panel to connect DVD recorder/player and set-top-box. Connect the audio and video cables from the external equipment's output jacks to the LCD display panel input jacks, as shown in the figure. When connecting the LCD display panel to external equipment, match the jack colours.

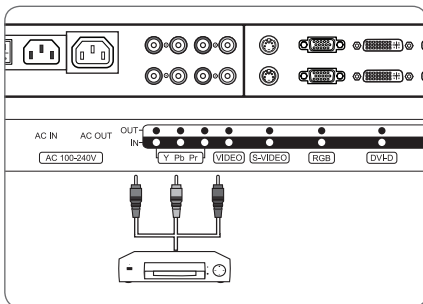

Connecting to External Devices

- 1 Plug the video cable according into the colours to the output sockets of the external devices.
- 2 Plug the other end of the video cable according to the colours into the [Y, Pb, Pr] sockets on the LCD display panel.

Connecting Several Devices

You can use the connections described parallel. On how to select the desired source see "Select Source" on page 20 and "Select Signal Source for PIP" on page 20.

■ Inserting the Batteries

For the operation of the remote control 2 type R03 1.5V Size AA batteries are included in the delivery.

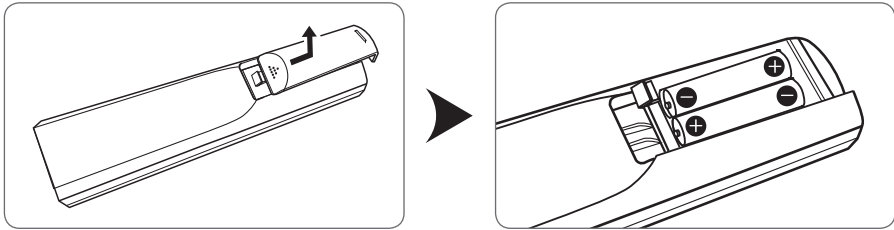

1 Remove the cover on the back of the remote control and insert the batteries.

■ Notes on Handling Batteries

When used properly batteries are a safe and reliable source of energy. However, when misused or not used according to the intention, they may leak. In extreme cases there is a danger of explosion or fire. Therefore please understand that the manufacturer will not be liable in case of misuse or improper use. For detailed information on how to handle the batteries, please contact the respective manufacturer.



- When inserting the batteries, ensure the polarity is matched correctly (+ and - marking on the battery and on the unit).
- Never try to recharge non-rechargeable batteries.



Disposal of batteries is clearly regulated by legal acts. Consumer quantities of batteries must be taken back by the dealer or by local public collectors. Never discharge batteries together with common waste. Make use of the free public collection system! Protect your environment. Return used batteries.

Settings

■ Switching on _____

- 1 Press the power switch on the back of the unit.
- 2 Press  on the remote control.
This switches the unit on and it can be operated using the remote control.



If it is not explicitly stated otherwise, it will be assumed that the unit and the LCD display panel set are switched on and will be operated by the remote control.



By default, the unit is set to the english language. For information on how to change the on-screen language later, refer to: "Set Screen Language" on page 16.

■ Switching Off _____

■ Stand by

- 1 Press  on the remote control.



Please note that the unit also consumes a little power when in stand by mode.

■ Switch Stand by Off

- 1 Press the power switch on the back of the unit.
Now the unit is switched off completely and does not consume any power.

■ Setting up for Operation _____

You can adjust various settings of the unit to adapt it to your requirements.

DIP Switch Setting(No.0~69)

Each Screen must have a unique ID number by DIP switch.

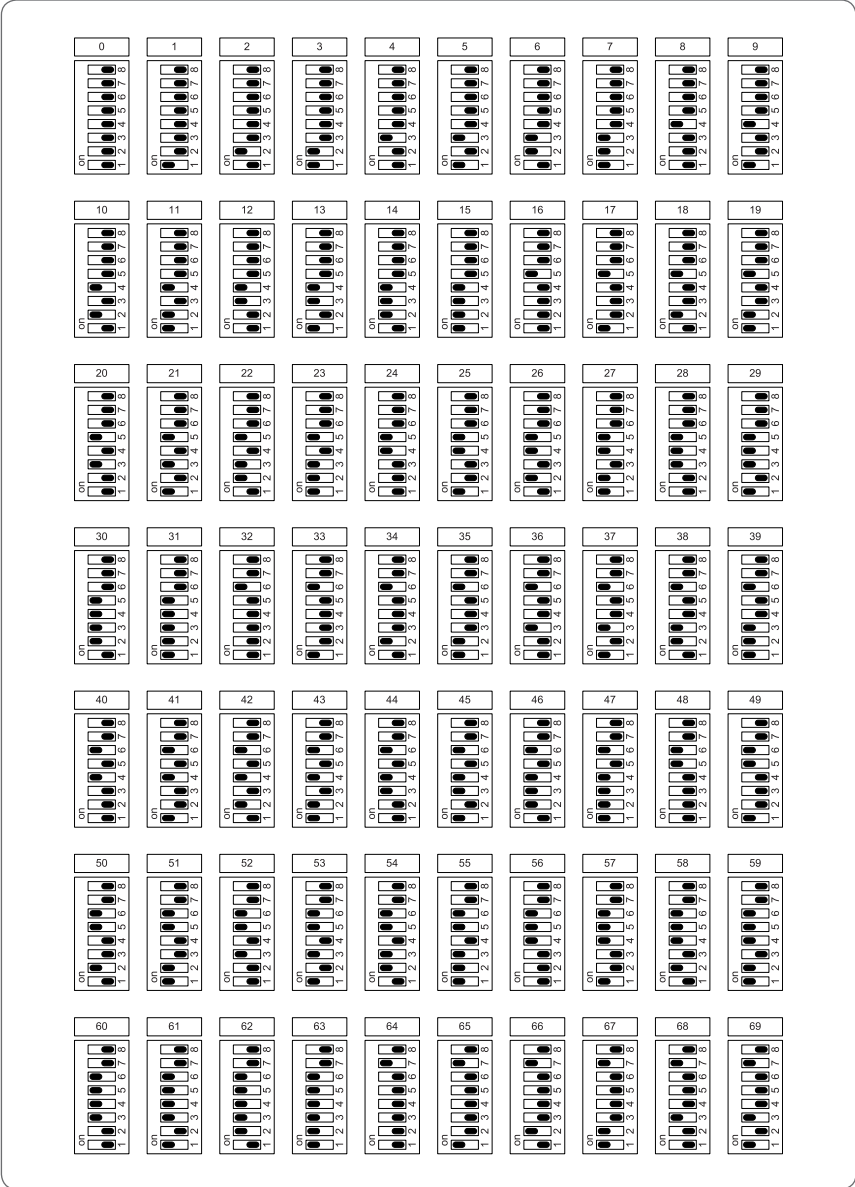

DIP Switch Setting(No.70~127)

Each Screen must have a unique ID number by DIP switch.

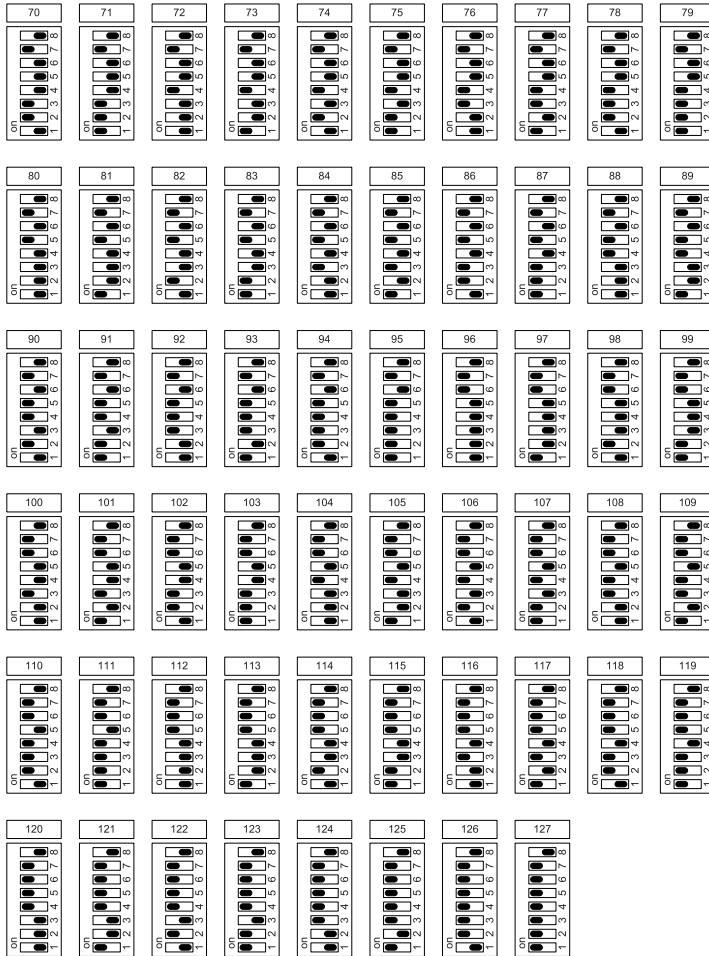

■ Setting ID example for LCD display panel

When connecting a number of LCD Display Panel through Displaychain(Link), surrounding noise may come out lower the image quality.

Daisy chain can connect with LCD display panel to maximum 16EA. (by DVI)

But, If you need additional connection, you must connect daisy chaining distributor.

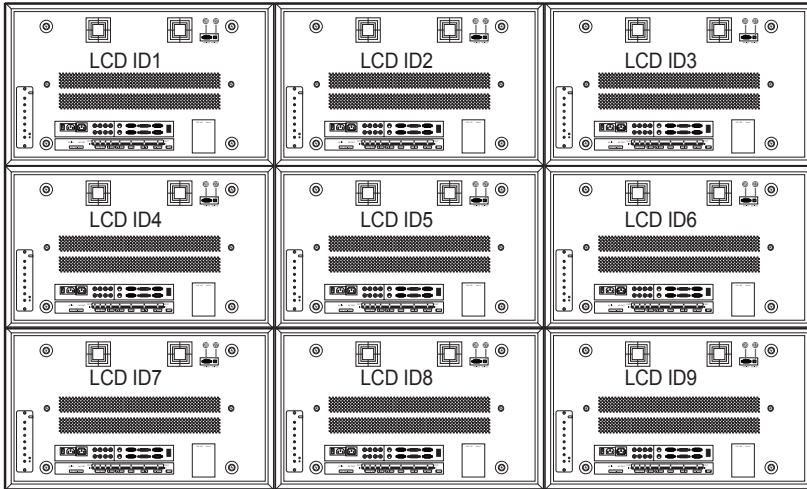

■ Connecting RS-232C Cable

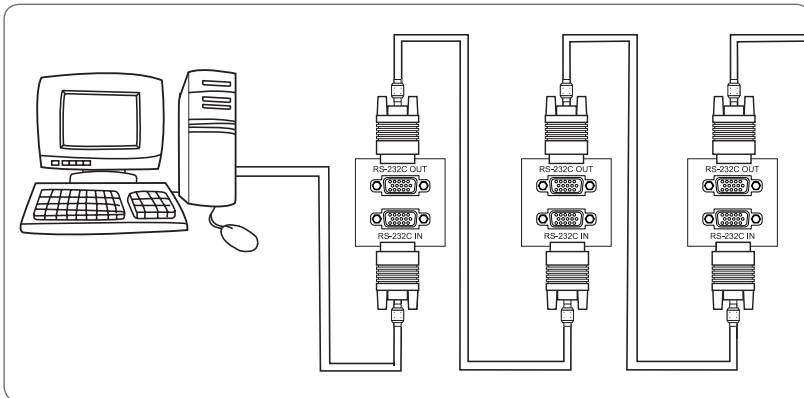

■ Connecting S-video Cable

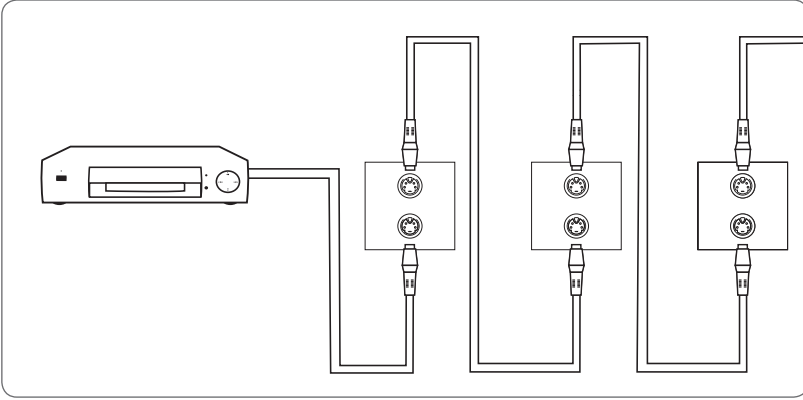

■ Connecting VGA Cable

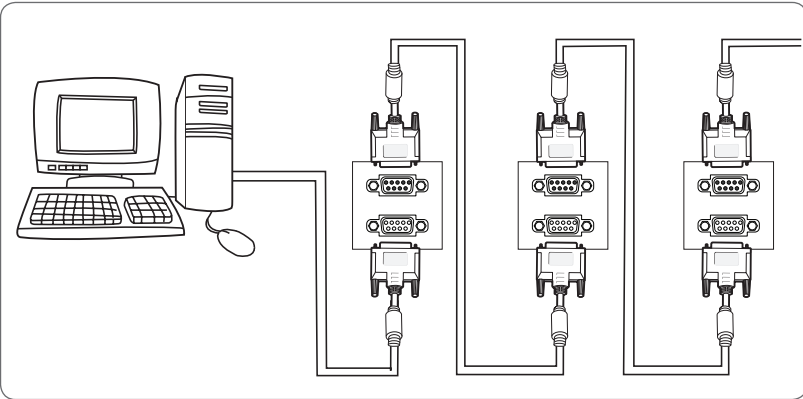

Connecting the Power Cord

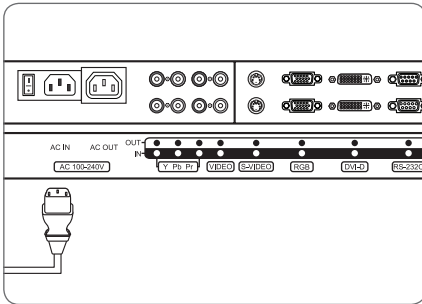

1 Connect the supplied power cord.

AC Power Connection



▪ Don't plug another AC power cord into extension cord. It's a good to start a fire. The maximum current is 15A in normal extension cord.

The AC power cord can be connected with Daisychain. But the maximum current must be restricted 15A.

- The Model CL-46CMH10/20 can be configured serially maximum 4 SETS in USA (AC100V).
- The Model CL-46CMH10/20 can be configured serially maximum 10 SETS in Europe (AC220V).
- The Model CL-55KMF10 can be configured serially maximum 4 SETS in USA (AC100V).
- The Model CL-55KMF10 can be configured serially maximum 10 SETS in Europe (AC220V).

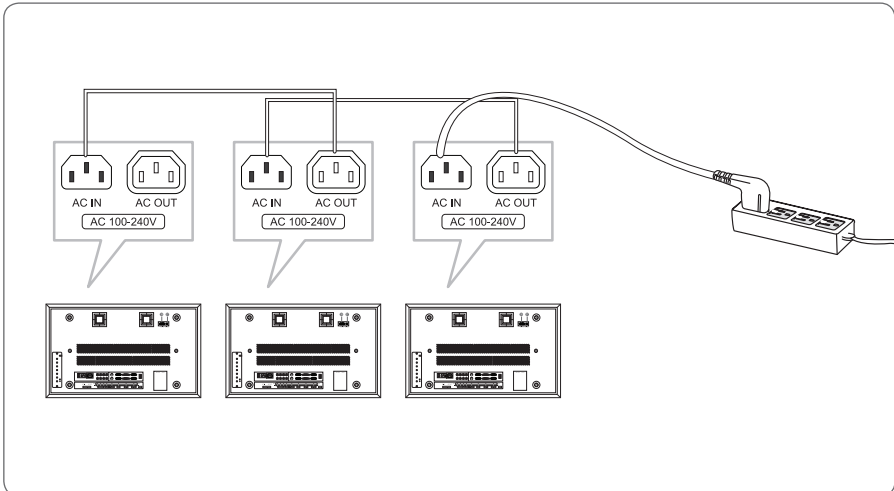

Set Screen Language

The screen display text can be displayed in several languages. Use this function to set screen language. By default, the unit is set to the english language.

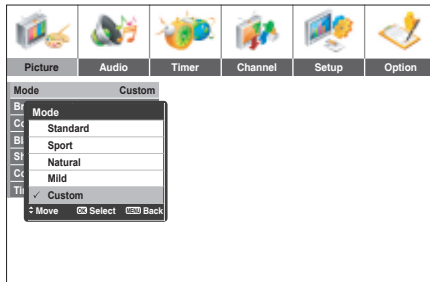

- 1 Press **MENU**.
- 2 Press **◀** or **▶** and select **Setup**.
- 3 Press **▲** or **▼** and select **OSD Language**.
- 4 Press **OK**.
- 5 Press **▲** or **▼** to select the desired setting.
- 6 Press **OK** to save the setting.
- 7 Press **EXIT**.

Set Geometry

Use this function to adjust screen status.

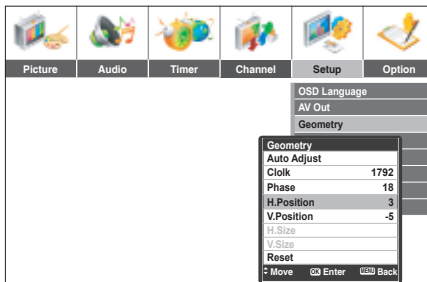

- 1 Press **MENU**.
- 2 Press **◀** or **▶** and select **Setup**.
- 3 Press **▲** or **▼** to select **Geometry**.
- 4 Press **OK**.
- 5 Press **▲** or **▼** to select the desired menu.
♦ If you want to reset to the factory default settings, select "Reset" and press **OK**.
- 6 Press **◀** or **▶** to adjust desired setting.
- 7 Press **EXIT**.

Set MISC.

Set RGB Input (Video or PC)

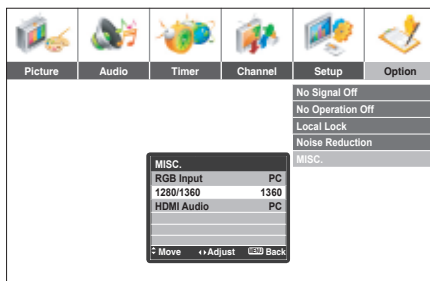

- 1 Press **MENU**.
- 2 Press **◀** or **▶** to select **Option**.
- 3 Press **▲** or **▼** to select **MISC.**
- 4 Press **OK**.
- 5 Press **▲** or **▼** to select **RGB Input**.
- 6 Press **◀** or **▶** to select desired setting.
- 7 Press **EXIT**.

■ Set Video Resolution (1280/1360)

- 1 Repeat steps from 1 to 4 in chapter “Set MISC.”
- 2 Press ▲ or ▼ to select **1280/1360**.
- 3 Press ◀ or ▶ to select desired setting.
- 4 Press .

■ Select Source (Main Input)

Use this function to select which signal will be displayed on the main screen, if you have connected several sources (e.g. a decoder and a roof aerial).

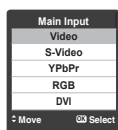

- 1 Press .

Remote Control

Default Display

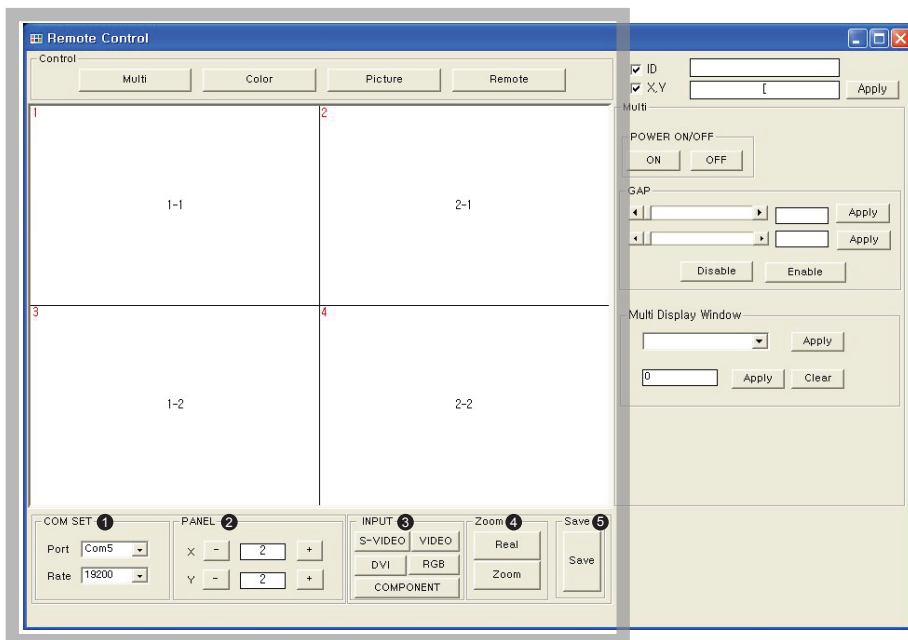

1 COM SET

Communications Port Setup

2 PANEL

Multi Screen Setup

Set up number of screen on X-Axis

Set up number of screen on Y-Axis

3 INPUT

Select input source

Select input source on chosen screen

4 ZOOM

Display enlargement / reduction

Real : Display full screen on each panel

Zoom : Display full screen on 2x2

5 SAVE

Save settings

※ To adjust settings, you should press "Apply" key.

Remote Control

Multi Tap

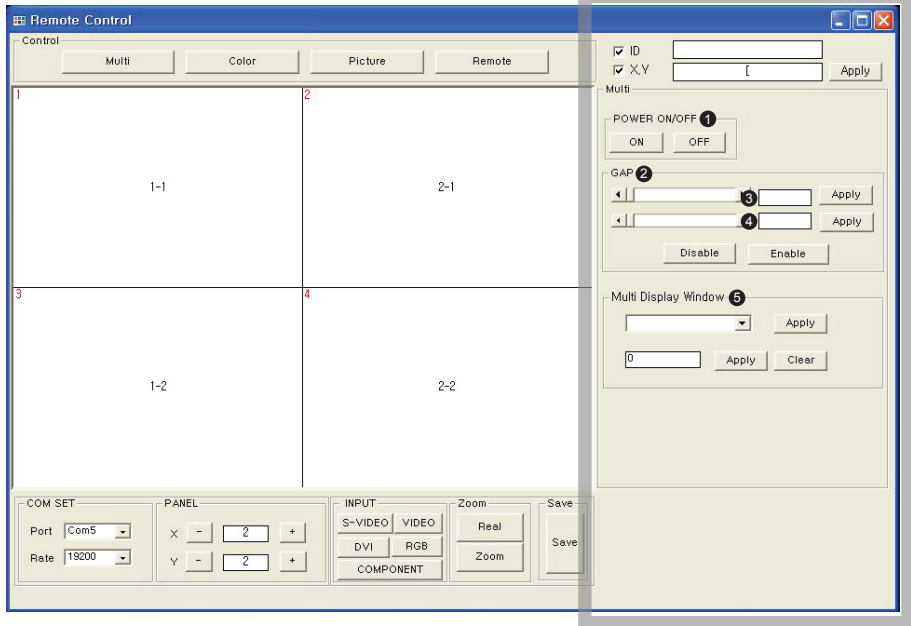

❶ POWER ON/OFF

Turn on/off the screen that you choose.

❷ GAP

Set up gap between screens.

❸ : Fix gap up-and-down.

❹ : Fix gap left-and-right.

❸ Multi Display Window

APL Code

Each unit set exchanges the APL (Average Picture Level) information each other on same time. The controller (APC) feeds back appropriate picture level each unit set.

It is automatically set up when you press the "zoom" key, and if you add optional code, choose the code value and press the "Apply" button.

Remote Control

Color Tap

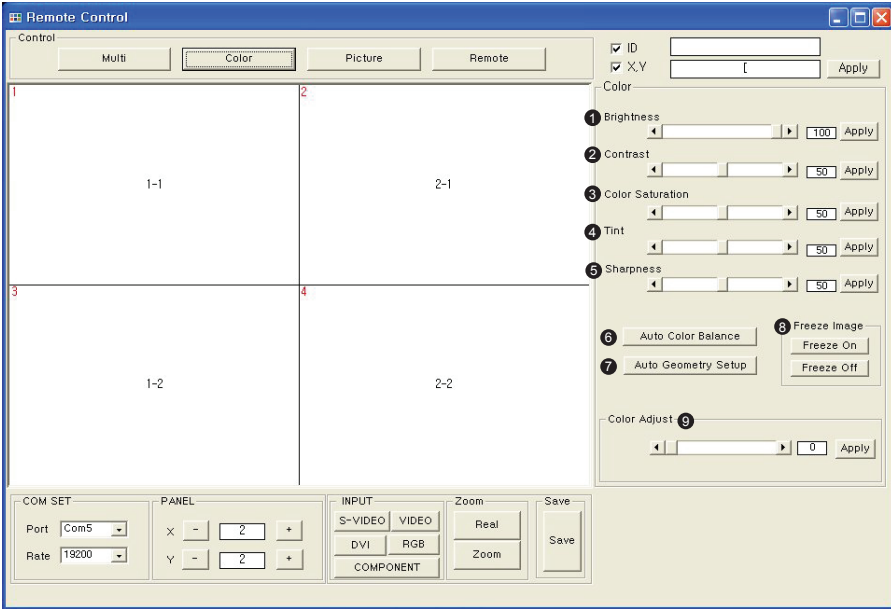

- 1 Brightness**
Adjust brightness on screen.
- 2 Contrast**
Adjust contrast on screen.
- 3 Color Saturation**
Adjust color saturation on screen.
- 4 Tint**
Adjust tint on screen.
- 5 Sharpness**
Adjust Sharpness on screen.
- 6 Auto Color Balance**
Balance color each panel automatically.
- 7 Auto Geometry Setup**
Setup auto positioning in "RGB" mode.
(When auto geometry setup, it should be in full-screen)
- 8 Freeze Image**
Show freeze-frame.
(But, actually screen is running.)
- 9 Color Adjust**
Change the value of warm and cold of the screen.
(20 is Normal)

* Handling white balance should be performed in Remote tap.

Remote Control

Remote Tap

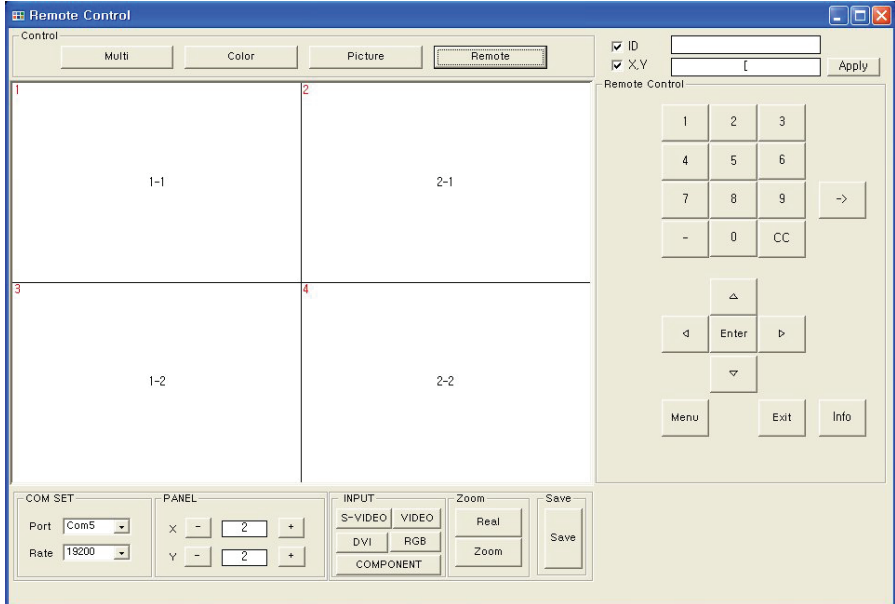

· Remote tap is used to set up for "Multi", "Color", "Picture". It can also substitute for the operation of remote control unit for additional adjustment.

· Factory Mode

Choose "Set" for Factory Mode.

Click "Menu" button → Click "Option" button → Click "1-4-4-6" button

→ Information window is set up for actual operation in the upper screen of left side

→ Click "Enter" → Set ready to enter "Factory Mode"

- Choose "Expert", be able to adjust white balance with R, G, B

- To initialize, choose "Factory Reset"

Troubleshooting

If there are problems with the unit, please check the following points before contacting the technical service.



Never open the unit. This may lead to electric shocks and will void the warranty.

No Picture or Sound	<ul style="list-style-type: none">• Make sure the receiver and the LCD display panel set are both connected to the power.
Black Screen	<ul style="list-style-type: none">• Check whether a signal source is selected. See chapter "Select Source" on page 20 and "Select MMC" on page 20.
Remote Control Does Not Work	<ul style="list-style-type: none">• Make sure the unit is connected to the power source.• Check whether the batteries are inserted correctly and whether they are sufficiently charged. To do this, insert new batteries for testing.
Message "No Signal "	<ul style="list-style-type: none">• Check whether the connecting cable is properly connected to the computer and the respective sockets.
Message "Video not Supported"	<ul style="list-style-type: none">• The resolution or the frequency of the graphic board in the computer cannot be displayed. Change the settings in the computer.
Picture Scrolls Vertically	<ul style="list-style-type: none">• Check whether the connecting cable is properly connected to the computer and the respective sockets.
Parts of the Picture are not Displayed	<ul style="list-style-type: none">• Check the resolution and the frequency of the graphic board in the computer. Adjust the settings. See chapter "Settings" on page 10.
Picture Too Small or Too Large	<ul style="list-style-type: none">• Adjust the settings. See chapter "Settings" on page 10.

Technical Specifications

General	Input voltage	AC 100-240 V, 50/60 Hz
	Operating temperature	0°C to 40°C
	Environment temperature	-20°C to +60°C
	Remote control	
	Type	Infrared
	Battery	Type R03 1.5 V Size AA
LCD	Pixel	Ø 1920 (1920 x RGB x 1080)
	Type	a-Si TFT active matrix
Video	Video system	CVBS, S-Video, RGB
Component Input	Y/Pb/Pr	Component 1/2; 480i/p, 576i/p, 720p, 1080ip
PC	Synchronization	30~61 kHz horizontal
		56~75 Hz vertical
	Colour display	16,7 M (true)
	Resolution Max.	Ø 1920 1920 x 1080
	Input signal	DVI, RGB, Component, Composite, S-Video
	Synchronization H/V separated	Positive or negative
WEB	MMC	Internet/Media player

Memo

